

Werkzeugkatalog

tool catalogue

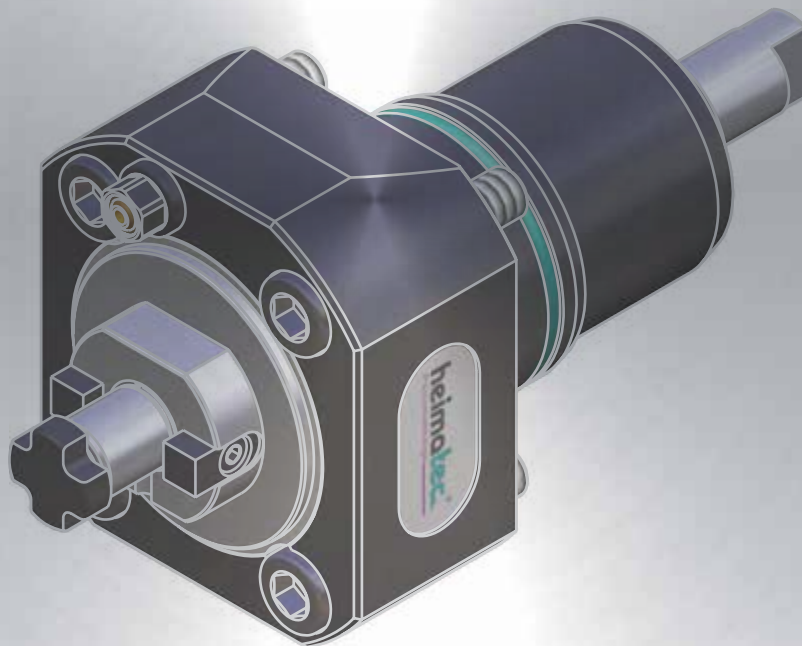

Nakamura

Super NTM 3

80er Revolver (55) / 80 turret (55)



Hinweis zu den AGBs:

Diese finden Sie in unserem Internetauftritt unter

www.heimatec.de

Home/Impressum/AGB

Terms and conditions:

You will find them on our website

www.heimatec.com

Home/Imprint/Terms and Conditions

Das Katalog-Werk einschließlich aller seiner Teile ist urheberrechtlich geschützt. Jede Verwertung außerhalb der engen Grenzen des Urheberrechtsgesetzes ist ohne Zustimmung der Rechteeinhaber unzulässig und strafbar. Das gilt insbesondere für Vervielfältigungen, Übersetzungen, Mikroverfilmungen und die Einspeicherung und Verarbeitung in elektronischen Systemen.

heimatec® GmbH behält sich Änderungen technischer Art jederzeit ohne Vorankündigung vor. Dies gilt insbesondere bei Anpassungen an neue oder geänderte internationale Normen oder bei Weiterentwicklungen unserer Produkte oder Herstellungsprozesse.

This catalogue, including all its parts, is protected by copyright. Each use outside the restricted limitations of the Copyright Act is inadmissible and liable to prosecution without the consent of heimatec. This is particularly valid for duplication, translation, microfilming and feeding and processing in electronic systems.

heimatec® GmbH reserves the right of technical changes everytime without advance notice, which is particularly valid for adaptations to new or changed international standards, or to developments of our products or manufacturing processes.

angetriebene Werkzeuge
driven tools



Axial-Bohr- und Fräskopf
axial drilling and milling head

$n_{max} = 6000 \text{ min}^{-1}$

8 010 55 033	ER 25 AX u-tec	EK	1:1
8 010 55 034	ER 25 AX u-tec	IK 25 bar	1:1
8 010 55 035	ER 25 AX u-tec	IK 70 bar	1:1
8 010 56 063	ER 32 AX u-tec	EK	1:1
8 010 56 064	ER 32 AX u-tec	IK 25 bar	1:1
8 010 56 065	ER 32 AX u-tec	IK 70 bar	1:1
8 010 56 059	easy quick HT 4	EK	1:1
8 010 56 066	easy quick HT 4	IK 25 bar	1:1
8 010 56 067	easy quick HT 4	IK 70 bar	1:1

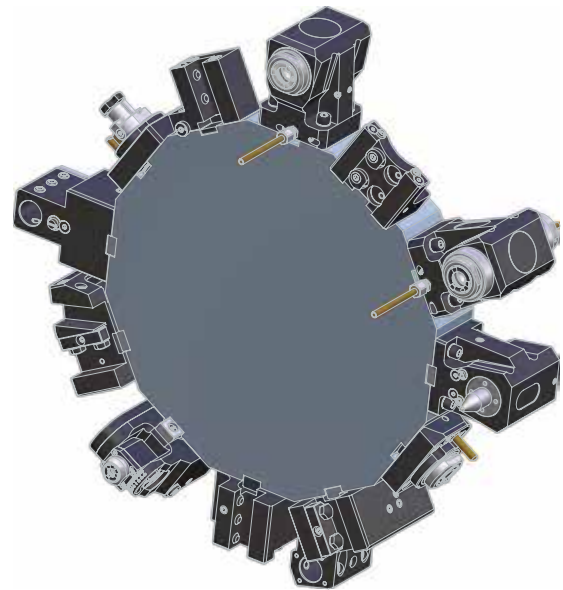

Axial-Bohr- und Fräskopf
axial drilling and milling head

$n_{max} = 6000 \text{ min}^{-1}$

8 010 56 032	easy quick HT 4	EK	1:1
8 010 56 031	easy quick HT 4	IK 25 bar	1:1

kurze Ausführung
short version



Axial-Bohr- und Fräskopf
axial drilling and milling head

Achsversatz / offset A=42

8 019 55 018	ER 25 AX u-tec	EK	1:1
8 019 55 023	ER 25 AX u-tec	IK 140 bar	1:1
$n_{max} = 6000 \text{ min}^{-1}$			
8 019 55 024	ER 25 AX u-tec	EK	1:2
8 019 55 025	ER 25 AX u-tec	IK 140 bar	1:2
$n_{max} = 12000 \text{ min}^{-1}$			
8 019 55 026	ER 25 AX u-tec	EK	1:3
8 019 55 027	ER 25 AX u-tec	IK 140 bar	1:3
$n_{max} = 18000 \text{ min}^{-1}$			
8 019 55 028	ER 25 AX u-tec	EK	2:1
8 019 55 029	ER 25 AX u-tec	IK 140 bar	2:1
$n_{max} = 3000 \text{ min}^{-1}$			



Axial-Bohr- und Fräskopf
axial drilling and milling head

$n_{max} = 24000 \text{ min}^{-1}$

8 013 54 005	ER 16 AX u-tec	EK	1:4
8 013 54 007	ER 16 AX u-tec	IK 70 bar	1:4



Axial-Bohr- und Fräskopf
axial drilling and milling head

$n_{max} = 6000 \text{ min}^{-1}$

8 011 54 012	Kombidorn/universal arbor 16	EK	1:1
8 011 55 015	Kombidorn/universal arbor 22	EK	1:1
8 011 54 006	Kombidorn/universal arbor 3/4"	EK	1:1
8 011 54 009	Kombidorn/universal arbor 1/2"	EK	1:1



Winkel-Bohr- und Fräskopf
radial drilling and milling head

Mittenmaß / center distance H=65
 $n_{max} = 6000 \text{ min}^{-1}$

8 030 55 092	ER 25 AX u-tec	EK	1:1
8 030 55 091	ER 25 AX u-tec	IK 140 bar	1:1
8 030 56 095	ER 32 AX u-tec	EK	1:1
8 030 56 096	ER 32 AX u-tec	IK 140 bar	1:1
8 030 56 072	easy quick HT 4	EK	1:1
8 030 56 075	easy quick HT 4	IK 140 bar	1:1



Winkel-Bohr- und Fräskopf radial drilling and milling head

Mittenmaß / center distance $H=65$
 $n_{max} = 3000 \text{ min}^{-1}$

8 030 55 063	ER 25 AX u-tec	EK	2:1
8 030 55 064	ER 25 AX u-tec	IK 140 bar	2:1
8 030 56 070	ER 32 AX u-tec	EK	2:1
8 030 56 090	ER 32 AX u-tec	IK 140 bar	2:1
8 030 56 073	easy quick HT 4	EK	2:1
8 030 56 059	easy quick HT 4	IK 140 bar	2:1



Winkel-Bohr- und Fräskopf radial drilling and milling head

Mittenmaß / center distance $H=77$
 $n_{max} = 12000 \text{ min}^{-1}$

8 030 55 122	ER 25 AX u-tec	EK	1:2
8 030 55 123	ER 25 AX u-tec	IK 140 bar	1:2
8 030 56 126	easy quick HT 4	EK	1:2
8 030 56 125	easy quick HT 4	IK 140 bar	1:2



Winkel-Bohr- und Fräskopf radial drilling and milling head

Mittenmaß / center distance $H=77$
 $n_{max} = 18000 \text{ min}^{-1}$

8 030 55 140	ER 25 AX u-tec	EK	1:3
8 030 55 139	ER 25 AX u-tec	IK 140 bar	1:3
8 030 56 124	easy quick HT 4	EK	1:3
8 030 56 121	easy quick HT 4	IK 140 bar	1:3



Winkel-Bohr- und Fräskopf radial drilling and milling head

Mittenmaß / center distance $H=65$
 $n_{max} = 24000 \text{ min}^{-1}$

8 030 54 042	ER 16 AX u-tec	EK	1:4
8 030 54 050	ER 16 AX u-tec	IK 140 bar	1:4



Winkel-Bohr- und Fräskopf radial drilling and milling head

Mittenmaß / center distance $H=65$
 $n_{max} = 6000 \text{ min}^{-1}$

8 031 54 014	Kombidorn/universal arbor 16	EK 1:1	
8 031 55 016	Kombidorn/universal arbor 22	EK 1:1	
8 031 56 012	Kombidorn/universal arbor 27	EK 1:1	
8 031 54 016	Kombidorn/universal arbor 3/4"	EK 1:1	
8 031 55 019	Kombidorn/universal arbor 1"	EK 1:1	

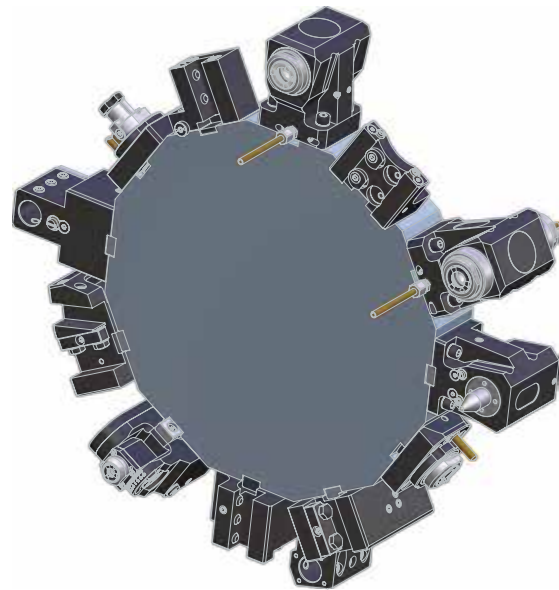

Winkel-Bohr- und Fräskopf radial drilling and milling head

Mittenmaß / center distance $H=65$
 $n_{max} = 6000 \text{ min}^{-1}$
doppelspindel / double spindle

8 039 55 042	ER 25 AX u-tec	EK	1:1
8 039 56 016	ER 32 AX u-tec	EK	1:1
8 039 56 009	easy quick HT 4	EK	1:1



Schwenkopf universal head

Mittenmaß / center distance $H=57$
 $n_{max} = 6000 \text{ min}^{-1}$

8 040 53 000	ER 11 A	EK	1:1
8 040 54 002	ER 16	EK	1:1



Schwenkopf universal head

Mittenmaß / center distance $H=69$
Achsversatz / offset $A=60$

8 043 54 000	ER 16 AX u-tec	EK	1:1
8 043 54 001	ER 16 AX u-tec	IK 140 bar	1:1
$n_{max} = 6000 \text{ min}^{-1}$			
8 043 54 002	ER 16 AX u-tec	EK	1:2
8 043 54 003	ER 16 AX u-tec	IK 140 bar	1:2
$n_{max} = 12000 \text{ min}^{-1}$			

▶ Weitere Ausführungen auf Anfrage
further versions on request

▶ Zubehör ZB...*
accessories ZB...*



▶ easy-quick



▶ u-tec





Winkel-Scheibenfräserkopf $\pm 10^\circ$ drehbar
radial disk mill head $\pm 10^\circ$ turnable

Mittenmaß / center distance $H=76$
auf 0° absteckbar / 0° can be pinned
 $n_{max} = 3000 \text{ min}^{-1}$
kein Kühlmittel / no coolant

8 037 53 001	$\varnothing 13$	2:1
8 037 54 015	$\varnothing 5/8''$	2:1
8 037 54 016	$\varnothing 1/2''$	2:1



Axial-Mehrspindel Werkzeuge 2-spindlig
axial multi spindle tools 2-spindles

Achsversatz / offset $A=56$
 $n_{max} = 6000 \text{ min}^{-1}$

8 050 54 001	ER 16 AX u-tec	EK	1:1
8 050 54 002	ER 16 AX u-tec	IK 25 bar	1:1



Axial-Mehrspindel Werkzeuge 3-spindlig
axial multi spindle tools 3-spindles

Achsversatz / offset $A=0 / 56$
 $n_{max} = 6000 \text{ min}^{-1}$

8 050 54 003	ER 16 AX u-tec	EK	1:1
--------------	----------------	----	-----



Winkel-Mehrspindel Werkzeuge 2-spindlig
angle multi spindle tools 2-spindles

Mittenmaß / center distance $H=65$
 $n_{max} = 6000 \text{ min}^{-1}$

8 053 54 000	ER 16 AX u-tec	EK	1:1
8 053 54 001	ER 16 AX u-tec	IK 25 bar	1:1

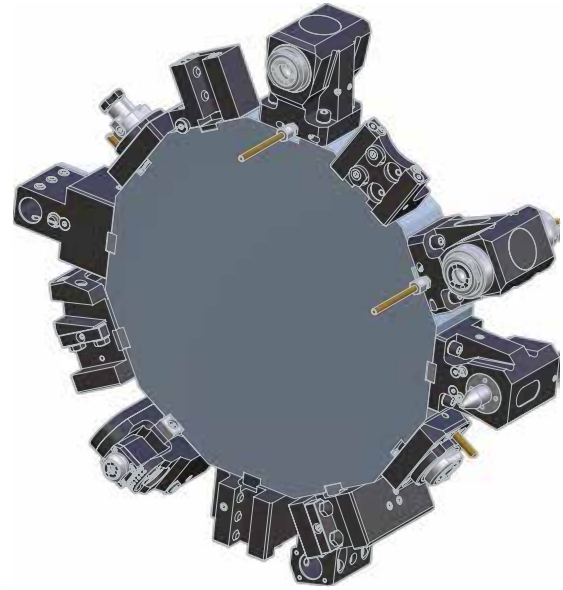

feste Werkzeuge
static tool holders

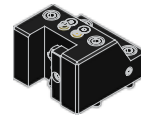

Kombi-Drehstahlhalter
universal turning holder

8 224 15 002	Vierkant/square 25/20	EK
8 224 15 012	Vierkant/square 1"	EK

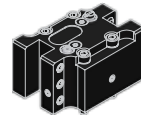

Doppel-Drehstahlhalter
double turning holder

8 251 11 003	Vierkant/square 20	EK
8 251 11 007	Vierkant/square 3/4"	EK



Abstechhalter / Drehhalter
cut-off holder / turning holder

8 224 11 005	Vierkant/square 20	(1)	EK
8 224 11 018	Vierkant/square 3/4"	(1)	EK
8 225 11 005	Vierkant/square 20	(2)	EK
8 225 11 012	Vierkant/square 3/4"	(2)	EK
8 224 11 003	Vierkant/square 20	(3)	EK
8 224 11 016	Vierkant/square 3/4"	(3)	EK
8 225 11 002	Vierkant/square 20	(4)	EK
8 225 11 009	Vierkant/square 3/4"	(4)	EK

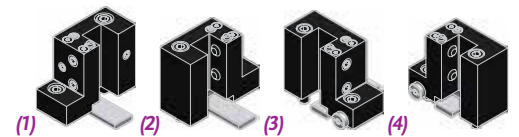



Abstechhalter
cut-off holder

8 224 13 007 SH 32 (1)
8 224 13 004 SH 32 (2)

EK
EK

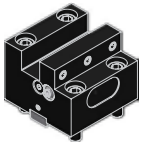
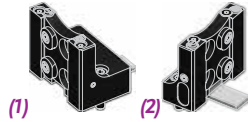

Kombi-Plandrehhalter
combi facing holder

8 244 11 002 Vierkant/square 20

EK



Plandrehhalter
facing holder

8 244 12 002 Vierkant/square 25
8 244 12 005 Vierkant/square 1"

EK
EK



Bohrstangenhalter
boring bar holder

Mittenmaß / center distance H=75

8 240 17 005 ø25
8 240 18 010 ø32
8 240 17 011 ø1"
8 240 18 033 ø1 1/4"

IK/EK
IK/EK
IK/EK
IK/EK



Bohrstangenhalter
boring bar holder

Mittenmaß / center distance H=75

8 240 18 012 ø32
8 240 17 049 ø1"

IK/EK
IK/EK



Doppel-Bohrstangenhalter
double boring bar holder

Mittenmaß / center distance H=47,5 / 82,5

8 253 17 016 ø25
8 253 17 034 ø1"

IK/EK
IK/EK

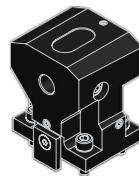
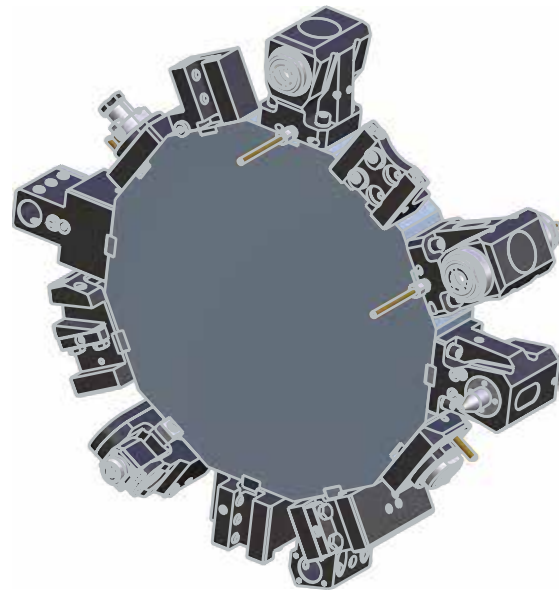

Halter für Wendplattenbohrer
insert drill holder

Mittenmaß / center distance H=75

8 240 15 007 ø16
8 240 16 009 ø20
8 240 17 023 ø25
8 240 18 021 ø32

IK
IK
IK
IK



Aufnahmehalter
tool holder

Mittenmaß / center distance H=75

8 240 15 006 ER 25
8 240 16 008 ER 32
8 240 16 004 easy quick HT 4

IK/EK
IK/EK
IK/EK

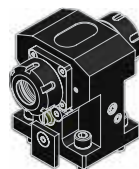

Doppel-Aufnahmehalter
double tool holder

Mittenmaß / center distance H=75

8 249 15 001 ER 25
8 249 16 000 ER 32
8 249 16 009 easy quick HT 4

IK/EK
IK/EK
IK/EK

▶ Weitere Ausführungen auf Anfrage
further versions on request

▶ Zubehör ZB...*
accessories ZB...*



▶ easy-quick



▶ u-tec



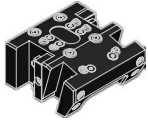

Kombi-Mehrfachdrehhalter
combi multiple holder

für ½ Stationen-Takt / for ½ station indexing

8 251 14 006 6x Vierkant/square 20 EK

8 251 14 018 6x Vierkant/square 3/4" EK

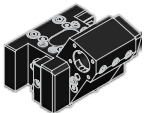

Mehrfachhalter
multiple holder

für ½ Stationen-Takt / for ½ station indexing
Mittenmaß / center distance H=82,5

8 259 19 004 4x Vierkant/square 20 +1x ø25 IK/EK

8 259 19 012 4x Vierkant/square 3/4"+1x ø1" IK/EK



Mehrfach-Bohrstangenhalter
multiple boring bar holder

für ½ Stationen-Takt / for ½ station indexing
Mittenmaß / center distance H=47,5/82,5

8 253 17 017 3x ø25 IK/EK

8 253 17 047 3x ø1" IK/EK



Stahlhalter mit rotierender Spitze
tool holder with rotating centering point

Mittenmaß / center distance H=75

8 263 19 002 EK



Halter für Zentriereinsatz
center holder

Mittenmaß / center distance H=55 oder / or 75

8 261 18 003 ø32 EK

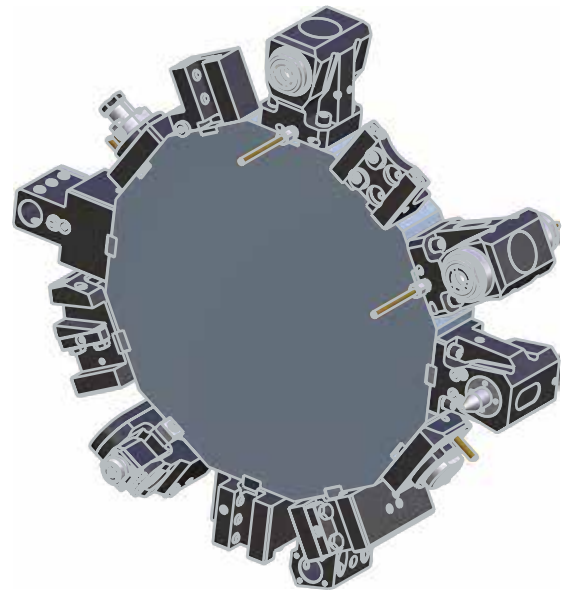

Hauptsitz/headquarters

heimatec® GmbH
Präzisionswerkzeuge
Carl-Benz-Straße 4
D- 77871 Renchen
Postfach 11 36
D- 77867 Renchen
Tel.: +49 (78 43) 94 66 0
Fax: +49 (78 43) 94 66 66
www.heimatec.de
info@heimatec.de

heimatec® Inc.
16 E. Piper Lane Suite 121
USA- 60070 Prospect Heights IL
Tel.: +1 (847) 749 0633
Fax: +1 (847) 749 2445
www.heimatecinc.com
info@heimatecinc.com

heimatec® - Ost, JSC
ul. Kozjubinskogo 4 ofice 209
RUS- 121351 Moskau
Tel.: +7 (495) 648 69 19
Fax: +7 (495) 648 69 19
www.heimatec-ost.ru
sales@heimatec-ost.ru

